

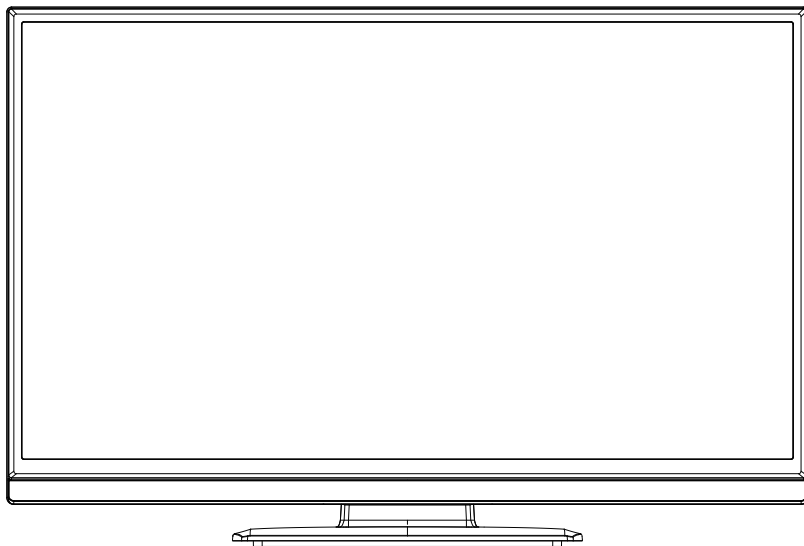

DP32D13

32" LED



HDTV LCD TV

ENGLISH

ESPAÑOL

FRANÇAIS

Need help?







www.sanyoctv.com



1-800-877-5032

Thank you for choosing SANYO. Please read all instructions to obtain maximum benefit of your product.

	CAUTION RISK OF ELECTRIC SHOCK DO NOT OPEN		THIS SYMBOL INDICATES THAT DANGEROUS VOLTAGE CONSTITUTING A RISK OF ELECTRIC SHOCK IS PRESENT WITH THIS UNIT.	
CAUTION: TO REDUCE THE RISK OF ELECTRIC SHOCK, DO NOT REMOVE COVER (OR BACK). NO USER-SERVICEABLE PARTS INSIDE. REFER SERVICING TO QUALIFIED SERVICE PERSONNEL.			THIS SYMBOL INDICATES THAT THERE ARE IMPORTANT OPERATING AND MAINTENANCE INSTRUCTIONS IN THE OWNER'S MANUAL WITH THIS UNIT.	

WARNING: TO REDUCE THE RISK OF FIRE OR ELECTRIC SHOCK, DO NOT EXPOSE THIS APPLIANCE TO RAIN OR MOISTURE.

Important Safety Instructions

1. Read these instructions.
2. Keep these instructions.
3. Heed all warnings.
4. Follow all instructions.
5. Do not use this apparatus near water.
6. Clean only with dry cloth.
7. Do not block any ventilation openings. Install in accordance with the manufacturer's instructions.
8. Do not install near any heat sources such as radiators, heat registers, stoves or other apparatus (including amplifiers) that produce heat.
9. Do not defeat the safety purpose of the polarized or grounding-type plug. A polarized plug has two blades with one wider than the other. A grounding type plug has two blades and a third grounding prong. The wide blade or the third prong are provided for your safety. If the provided plug does not fit into your outlet, consult an electrician for replacement of the obsolete outlet.
10. Protect the power cord from being walked on or pinched, particularly at plugs, convenience receptacles, and at the point where they exit from the apparatus.
11. Only use attachments/accessories specified by the manufacturer.
12. Use only with the cart, stand, tripod, bracket or table specified by the manufacturer or sold with the apparatus. When a cart is used, use caution when moving the cart/appliance combination to avoid injury from tip-over.
13. Unplug this apparatus during lightning storms or when unused for long periods of time.
14. Refer all servicing to qualified service personnel. Servicing is required when the appliance has been damaged in any way, such as power-supply cord or plug is damaged, liquid has been spilled or objects have fallen into apparatus, the apparatus has been exposed to rain or moisture, does not operate normally or has been dropped.
15. If an outside antenna is connected to the television equipment, be sure the antenna system is grounded so as to provide some protection against voltage surges and built up static charges. In the U.S. Selection 810-21 of the National Electrical Code provides information with respect to proper grounding of the mast and supporting structure, grounding of the lead-in wire to an antenna discharge unit, size of grounding conductors, location of antenna discharge unit, connection to grounding electrodes, and requirements for the grounding electrodes.
16. An outside antenna system should not be located in the vicinity of overhead power lines or other electrical light or power circuits



or where it can fall into such power lines or circuits. When installing an outside antenna system, extreme care should be taken to keep from touching such power lines or circuits as contact with them might be fatal.

EXAMPLE OF ANTENNA GROUNDING ACCORDING TO NATIONAL ELECTRICAL CODE, ANSI/NFPA 70

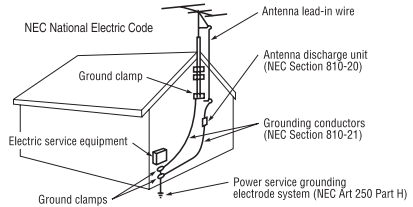

Note to CATV system installer: This reminder is provided to call the CATV system installer's attention to Article 820-40 of the NEC that provides guidelines for proper grounding and, in particular, specifies that the cable ground shall be connected to the grounding system of the building, as close to the point of cable entry as practical.

17. Wall or Ceiling Mounting - The product should be mounted to a wall or ceiling only as recommended by the manufacturer and listed by an independent laboratory (such as UL).
18. Apparatus shall not be exposed to dripping or splashing and no objects filled with liquids, such as vases, shall be placed on the apparatus.
19. When the MAINS plug is used as the disconnect device, the disconnect device shall remain readily operable.
20. Install the LCD TV in a proper position. If not, it may result in a fire hazard.
21. Provide appropriate space on the top, sides and rear of the LCD TV cabinet for allowing air circulation and cooling the LCD TV.
22. Minimum clearance must be maintained. If the LCD TV is to be built into a compartment or similarly enclosed, the minimum distances must be maintained. Do not cover the ventilation slot on the LCD TV. Heat build-up can reduce the service life of your LCD TV, and can also be dangerous.

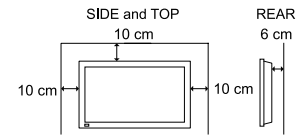

FCC Information

This equipment has been tested and found to comply with the limits for a Class B digital device, pursuant to Part 15 of the FCC Rules. These limits are designed to provide reasonable protection against harmful interference in a residential installation. This equipment generates, uses and can radiate radio frequency energy and, if not installed and used in accordance with the instructions, may cause harmful interference to radio communications. However, there is no guarantee that interference will not occur in a particular installation. If this equipment does cause harmful interference to radio or television reception, which can be determined by turning the equipment off and on, the user is encouraged to try to correct the interference by one or more of the following measures:

- Reorient or relocate the receiving antenna.
- Increase the separation between the equipment and receiver.
- Connect the equipment into an outlet on a circuit different from that to which the receiver is connected.
- Consult the dealer or an experienced radio/TV technician for help.

FCC Warning

Changes or modifications not expressly approved by the party responsible for compliance with the FCC Rules could void the user's authority to operate this equipment.

Cables

Connections to this device must be made with shielded cables with metallic RF/EMI connector hoods to maintain compliance with FCC Rules and Regulations.

Canadian Notice

CAN ICES-3 (B)/NMB-3(B)

Standard Television Receiving Apparatus-Appareil de réception télévision ordinaire, Canada BETS-7 / NTMR-7.

ENERGY STAR® User Information

ENERGY STAR User Information Statement: the factory default settings of this television meet ENERGY STAR requirements. Changing Picture Settings may increase energy consumption, possibly beyond the limits required for ENERGY STAR qualification.

To ensure your television is operating at an optimal energy efficiency, select default picture mode.

Trademarks



Manufactured under license from Dolby Laboratories.

Dolby and the double-D symbol are trademarks of Dolby Laboratories.



HDMI, the HDMI logo and High-Definition Multimedia Interface are trademarks or registered trademarks of HDMI Licensing LLC in the United States and other countries.



As an Energy Star® Partner, Sanyo Electric co., Ltd. has determined that this product meets the Energy Star® guidelines for energy efficiency.



This symbol on the nameplate means the product is Listed by Intertek Testing Services Taiwan Ltd. It is designed and manufactured to meet rigid U.L. safety standards against risk of fire, casualty and electrical hazards.



RECYCLING OF SANYO TELEVISIONS:

SANYO television customers should contact MRM Recycling at 888-769-0149 or visit their website at www.mrmrecycling.com regarding SANYO's waste management plan.

Protecting the Screen

CAUTION: The screen can be damaged if it is not maintained properly.

- Do not use hard objects such as hard cloth or paper to clean the screen.
- Do not use excessive pressure when cleaning the screen; excessive pressure can cause permanent discoloration or dark spots.
- **NEVER** spray liquids on the screen.



Handling Precautions

- Handle by the cabinet only.
- Handling by two or more people is recommended.
- Never touch the screen when handling.
- Handling damage is **not** covered under warranty.



Contents

Important Safety Instructions	2	Problems and Solutions	18
FCC Information	3	Specifications	19
FCC Warning.....	3	Supported Timing Table	20
Cables	3		
Canadian Notice	3		
ENERGY STAR® User Information	3		
Trademarks	3		
Protecting the Screen	3		
Handling Precautions	3		
Installation	5		
Accessories	5		
Positioning the TV	5		
Caution Installing Stand	5		
Installing Stand	6		
Wall Mounting (Optional).....	6		
Getting Started	7		
Install Batteries in the Remote Control.....	7		
Operating Range of the Remote Control....	7		
Antenna Connection for Off-air Signals.....	7		
Controls and Jacks.....	8		
Wireless Remote Control	9		
Connection	10		
HDMI to HDMI Connection	10		
Component (YPbPr) Connection	10		
Video Connection (Shared With Component-Y)	11		
Digital Audio Connection.....	11		
PC Connection.....	11		
USB Connection	12		
Power Connection	12		
Initial Setup	12		
OSD Menu Operation	14		
Video Menu	14		
Audio Menu	15		
Channels Menu	15		
Setup Menu.....	16		
Photos Menu	17		
To control while in photo folder:	17		
To control while in full-screen photo show:	17		
To control while in photo slideshow: ..	17		
Data Format for USB Photo Viewer...	17		



Installation

Accessories

- (1) Stand Base
- (4) M4x14 Screws
- (1) Remote Control
- (1) Power Cord
- (1) User Manual
- (1) Return to Policy

Positioning the TV



- Always use a firm and flat surface when positioning your HDTV.
- Do not position the HDTV in a confined area.
- Allow adequate space for proper ventilation.
- Do not position the HDTV where it is easily reachable by small children and may present risk of injury.

The American Academy of Pediatrics discourages media use by children younger than two years. For more information, visit www.aap.org.

Caution Installing Stand

- Handling by two people is recommended when installing.
- When holding (moving or lifting) the LCD TV, hold the display's body. Do not handle the LCD TV by holding the attached accessory parts (speakers), otherwise it may result in damage.
- Before installing, provide a desk (or a part of it) which is strong enough to support the weight of the LCD TV and its stand. The desk must be larger than the LCD TV's screen size. The desk's surface must be flat and covered with soft material (such as a blanket) for protecting the screen surface.
- Before putting the LCD TV on the desk, make sure there is no object on it. Leaving any object under the screen may cause damage on the screen.
- The LCD TV with this stand should be installed on a flat and level place. Do not place it on non flat, unlevel or unstable cart or stand. The display may fall, causing not only serious damage to the products but serious injury to a person.

For correct installing, mounting and uninstalling of the LCD TV Stand, it is strongly recommended to use a trained, authorized dealer. Failure to follow correct procedures could result in damage to the equipment or injury to the installer.



Installing Stand

1. Place the LCD TV on a flat surface place where maintained with soft materials (such as a blanket) to protect the display screen.

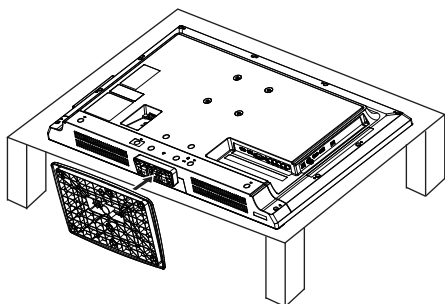

2. Secure the stand-base to the LCD TV with 4 screws (M4x14) found in the accessory bag.

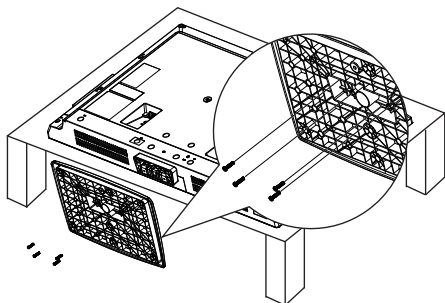

WARNING:

- To prevent injury, this apparatus must be securely attached to the floor/wall in accordance with the installation instructions.
- This LCD TV could fall over if it is pushed, pulled or knocked down. It would be safer to use a screw to secure the LCD TV to desktop.

Screw type:

(Not supplied with TV)

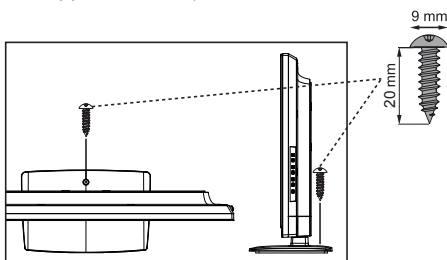

Wall Mounting (Optional)

Please install on wall by using a wall-mount bracket. (Not supplied with TV)

- VESA standard interface: 100 x 100mm
- Screw type: M4x16 (Not supplied with TV)

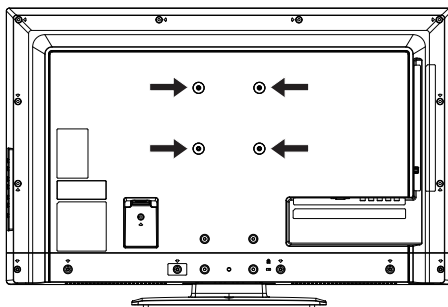

NOTE:

1. Wall mounting kit is not supplied.
2. Wall mounting kit shall be able to sustain at least 3 times of set weight.

We suggest that you keep your LCD TV at least 2.36 inches (60 mm) away from the wall to prevent cable interference and to make room for a better heat dissipation.

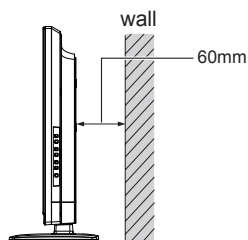

IMPORTANT: Wall mount kit must comply with VESA standard 100 x 100. All four (4) screws must be threaded to the wall mount and HDTV's back cabinet.



Getting Started

Install Batteries in the Remote Control

1. Open the battery cover of the remote control by pressing down and pulling it.

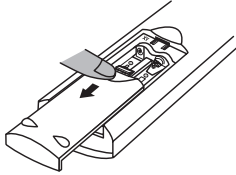

2. Insert two new **AAA** size batteries for the remote control. Make sure to match the **+** and **-** signs on the batteries with marks inside the remote control.

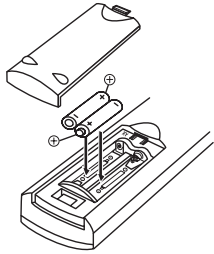

3. Close the battery cover until it clicks shut.

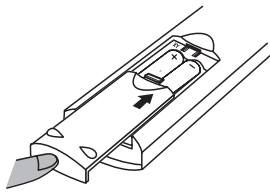

- Do not use rechargeables together with dry cells, other types, mixed new and old or batteries with different charge levels.
- Do not expose the remote control or batteries to moisture or heat such as sunshine.
- Please recycle used up batteries.
- Remove the batteries if the remote control is not going to be used for an extended period of time.
- Danger of explosion if batteries are incorrectly replaced.
- Replace batteries only with the same or equivalent type.

Operating Range of the Remote Control

Point the top of the remote control toward the TV's sensor within a distance of less than 6m/20ft, and a horizontal/vertical angle of less than 30 degrees.

The remote control may not function properly if the TV's sensor is under direct sunlight or strong illumination, or when there is obstacle in the path of signal transmission.

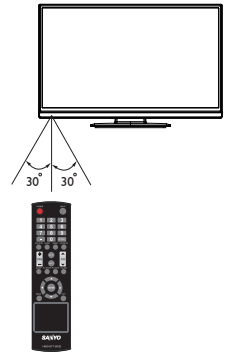

Antenna Connection for Off-air Signals.

The tuner in this LCD TV can receive digital and analog off-air signals from an antenna, or analog or clear QAM cable channels from a direct Cable TV connection.

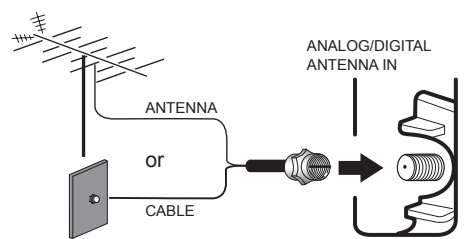

NOTES:

- You must use the On-screen Menu to Search for Clear QAM Cable channels. (see p.14)
- For the best picture, connect your Cable box or Satellite receiver to HDMI or component jacks.
- This LCD TV can receive ANT unscrambled RF signal being broadcasted.

Controls and Jacks

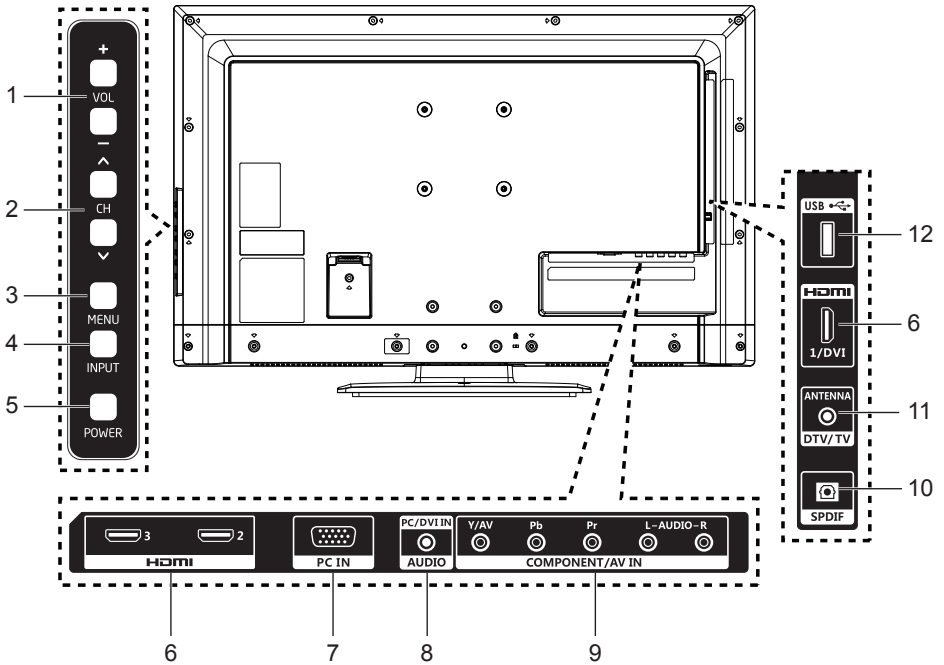

1. **VOL + / -**: Turn up(+) or turn down(-) the audio volume. In the OSD Menu mode, move right(+) or move left(-) the menu selection.
2. **CH ^ / ∨**: Select the next(^) or the previous(∨) channel. In the OSD Menu mode, move up(^) or move down(∨) the menu selection.
3. **MENU**: Enter or exit the menu screen.
4. **INPUT**: Select the input source.
5. **POWER**: Turn the TV On or Off (standby).
6. **HDMI (HDMI1/DVI, HDMI2, HDMI3)**: Connect your HDMI devices.
7. **PC IN**: Connect your PC video.
8. **PC/DVI IN AUDIO**: Connect your PC/DVI audio (3.5mm stereo).
9. **COMPONENT/AV IN**: Connect digital video equipment to the Video Green (Y), Blue (Pb), Red (Pr) jacks, and matching Audio White (L) and Red (R) jacks.
10. **SPDIF**: Use a digital audio cable to connect stereo home theater system.
11. **ANTENNA/DTV/TV**: Connect an RF antenna or Analog Cable system.
12. **USB PORT**: Used for accessing JPEG photo files.

Wireless Remote Control

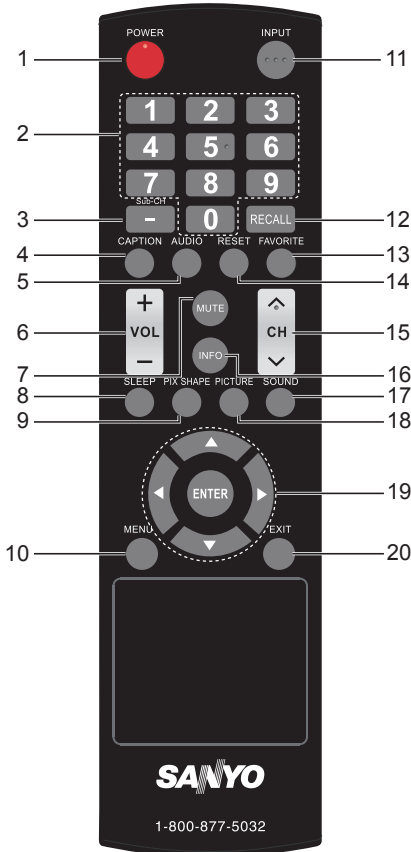

1. **POWER** - Press to power on the TV.
2. **Numeric Buttons** - Press to select a channel.
Example: Press 6 then ENTER button to select channel 6. Press 6 and 1 then ENTER button to select channel 61.
3. **— Button** - Press numeric button then press this button followed by the desired digital sub-channel.
4. **CAPTION** - Press this button to switch CC mode among **CC Off**, **CC On**, and **CC On When Mute**. Digital Captions can be changed through the the Digital setting from Closed caption menu.
5. **AUDIO** - Press to select the desired audio mode, if available.
6. **VOLUME UP / DOWN (VOL + / —)** - Press to decrease or increase the audio volume.
7. **MUTE** - Press to mute or restore the sound.
8. **SLEEP** - Press to set **Off Timer** function among **Off, 5, 10, 15, 30, 60, 90, 120, 180,** or **240** minutes.
NOTE: The **Off Timer** will be canceled when the LCD TV is turned off or when a power failure occurs.
9. **PIX SHAPE** - Press to choose aspect ratio: **Normal, Zoom, Wide, Cinema,** or **Auto**. Available options depend on the signal and the aspect ratio of the broadcast.
10. **MENU** - Press to display on-screen menu.
11. **INPUT** - Press to select the input source to view.
12. **RECALL** -
In TV mode: Press to switch between the last and current TV channel.
In none-TV mode: Press to switch between the last and current none-TV input-source
13. **FAVORITE** - Accesses the Favorites channel.
14. **RESET** - Press twice to display RESET menu. Select "Yes" to reset to Factory Default settings.
NOTE: All the channel memory will be erased. You will have to run the Initial Setup again. Please refer to page 12 for running Initial Setup.
15. **CHANNEL UP / DOWN (CH ^ / v)** - Press to switch to the previous or next channel.
16. **INFO** - Press to display channel information banner.
Digital Banner may contain: Channel Number, Channel Title, Video Resolution, and Program Rating.
Analog Banner may contain: Channel Number, Channel Title, NTSC, and Program Rating.
17. **SOUND** - Press to select one of the preset audio modes: **Standard, Movie, Music, News,** or **Custom**.
18. **PICTURE** - Press to select one of the preset picture modes: **Vivid, Natural, Standard, Cinema,** or **Custom**.
19. **Cursor ▲ (UP) and ▼ (DOWN)** - Press to move the cursor up and down.
Cursor ◀ (LEFT) and ▶ (RIGHT) - Press to move the cursor left and right.
ENTER - Press to select an option from the menu, when required.
20. **EXIT** - Press to exit from the menu.

Connection

The cables in these following connection examples are used for illustration only, and are not supplied in the package.

HDMI to HDMI Connection

Connect compatible Digital devices such as HD Cable Box, HD Satellite Receiver, DVD Player, and Game System.

HDMI-High-Definition Multimedia Interface.

This is a digital AV interface that accepts uncompressed video signals for the best picture quality possible. It supports HDCP copy protection and allows transmission of copy-protected digital content.

The signal can also include PCM audio, when available.

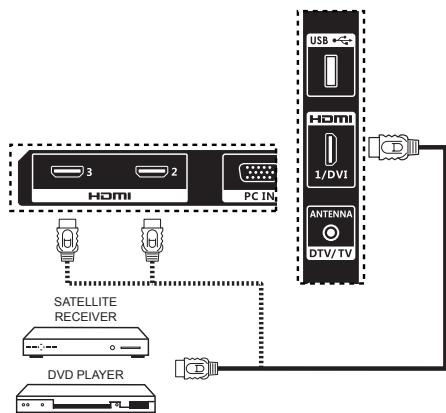

1. Connect the HDMI input and your external device with HDMI cable.
2. Press the [INPUT] button to select [HDMI1], [HDMI2], or [HDMI3] as the input signal.

Component (YPbPr) Connection

Connect Digital devices such as a HD Cable Box, HD Satellite Receiver, DVD Player, and Game System.

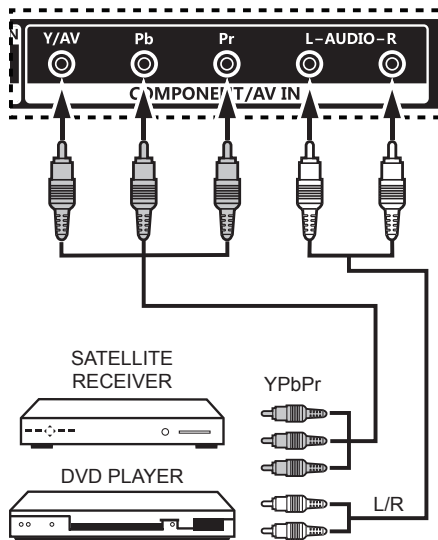

1. Connect a COMPONENT cable to the Green, Blue, and Red video jacks on the LCD TV and to your digital device as shown.
2. Connect an AUDIO cable to the matching White and Red audio jacks as shown.
3. Press the [INPUT] button to select [Component] as the input signal.

Video Connection (Shared With Component-Y)

Composite connectors are included on your LCD TV to provide continued compatibility with older analog devices such as a VCR.

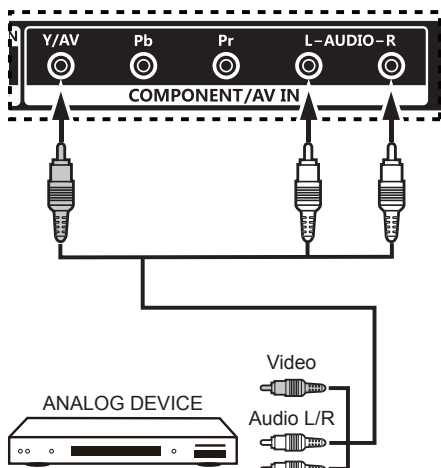

1. Connect an AV cable to the jack on the LCD TV and to your analog AV equipment as shown.
2. Press the [INPUT] button to select [AV] as the input signal.

Digital Audio Connection

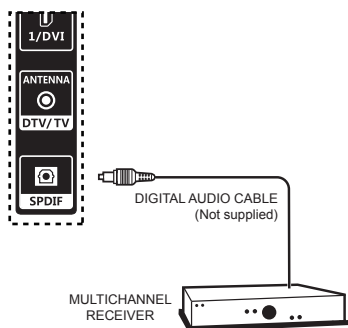

1. Connect the Digital Audio output to a multichannel receiver as shown.
- NOTE:**
- Dolby Digital audio signal is available from the Digital Audio output terminal only when receiving as part of a Digital input on the screen.

PC Connection

DVI to HDMI Connection

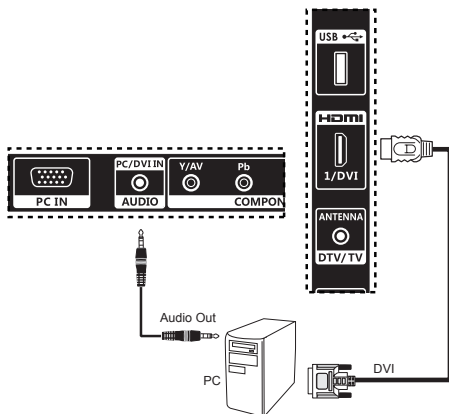

1. Use an adapter (not supplied) to connect a DVI device to an HDMI input jack.
2. Press the [INPUT] button to select [HDMI1] as the input signal.

NOTE:

- Only **HDMI1** input supports this function.

D-Sub Connection

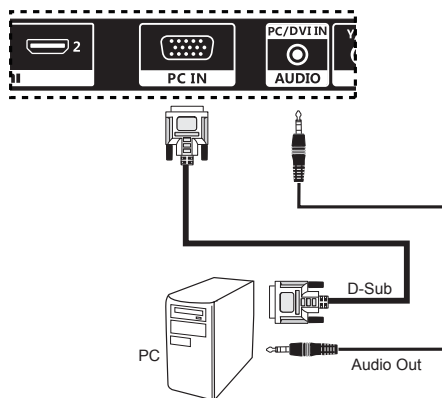

1. Connect with RGB (D-Sub 15 Pin) video cable from the RGB output of your PC to the TV **PC IN** input.
2. For PC audio signal, connect with an analog audio cable from the audio output of your PC to the TV **PC/DVI IN AUDIO** input.
3. Press the [INPUT] button to select [PC] as the input signal.

USB Connection

Your LCD TV features a JPEG Photo Viewer that allows watching digital still pictures from your USB disk plugged to the USB slot at the side panel.

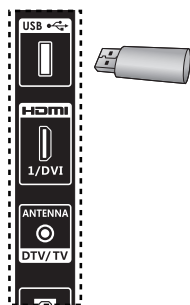

1. Plug your USB disk to the USB slot at the side panel.
2. Press the [INPUT] button to select [USB] as the input signal (see page 17 for detail).

Power Connection

1. Plug in AC power cord (120V AC, 60Hz)
2. Press the [POWER] button, (Follow the on-screen instructions).

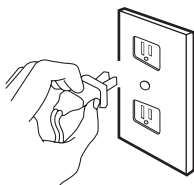

Initial Setup

For the first time after powering on your LCD TV, the Setup Wizard appears.

1. Select the language used for the OSD (On-Screen-Display) Menu.



2. Select either **Home** or **Shop** mode.

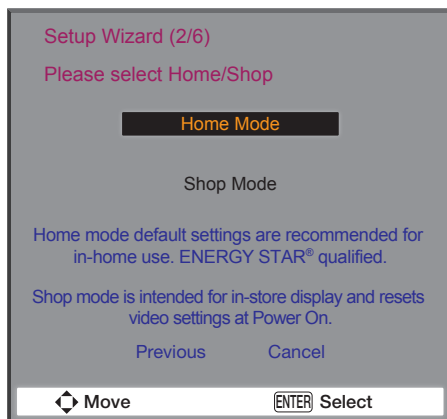

If later you want to change the mode, you can change it via the **Home/Shop** selection under **Energy Options** on the **Setup** menu (See page 16).

NOTE:

- The **Home** mode is intended for home use, and will save much energy.
- Any menu or control changes in the Shop mode will not be saved when the LCD TV is turned off.

3. Select the tuning band: **Antenna** for external antenna, **Cable** for cable system, or through your **Set Top Box**.

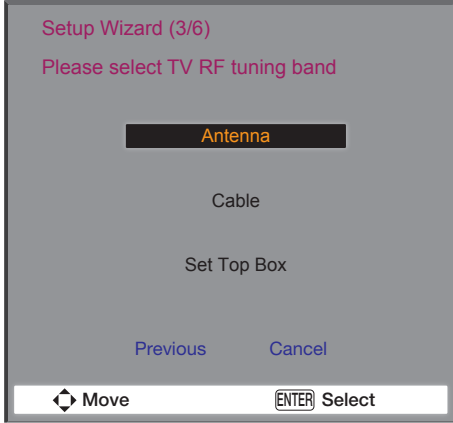

To cancel the process, press [ENTER] button on the remote control.

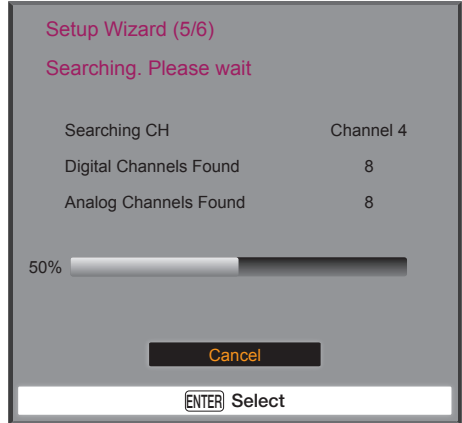

4. Press [ENTER] button to start the channel scan.



NOTE:

- Once you cancel the Setup Wizard, it will not be shown again.
6. The **Setup Wizard** is done now. You may press [EXIT] button on the remote control to tune to the first detected channel right away.



5. The channel scanning is now in process. The Setup Wizard shows the scanning process of digital channels first, and then the analog channels next.
The scanning process will show how many channels in total have been found. Please wait while the scanning process is searching for the available channels in your area.

NOTE:

- The **Setup Wizard** will not appear again once you have completed. For updating or adding channels, refer to the **Add/Skip Channels** feature on page 15.

OSD Menu Operation

To enter the OSD (On-Screen Display):

1. Press [MENU] button on the remote control to display the OSD menu.
2. Use the cursor buttons (▲▼◀▶) to highlight your selection.
3. Press [ENTER] button to confirm your selection.
4. Press [EXIT] button to exit from any menu layer instantly.

Video Menu

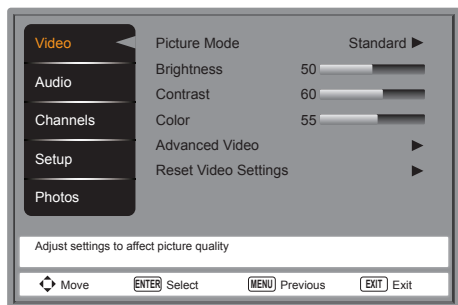

Picture Mode

Enter this menu to select from preset picture settings to optimize your TV's performance.

- **Vivid:** Provides enhanced picture contrast and sharpness for viewing in a well-lit room.
- **Natural:** Provides a highly defined image for viewing in a normally-lit room.
- **Standard:** Provides a less power consuming settings.
- **Cinema:** Provides a soft, film-like picture for watching movies in a darkened room.
- **Custom:** Any changes made to the other modes will be applied to this mode.

Brightness

Adjust picture brightness.

Contrast

Adjust picture contrast.

Color

Adjust picture color.

Advanced Video

Select advanced video settings.

- **Color Temperature:** Selects a choice of **Cool** (blue), **Normal**, or **Warm** (red) color.
- **Noise Reduction:** Set to reduce video noise.
- **Tint:** Adjust the hue (red, green, blue) of the picture.
- **Sharpness:** Set to enhance the picture detail.
- **Adaptive Contrast:** Set to automatically adjust the picture detail and brightness.
- **Aspect Ratio:** Adjust how the picture fills the screen.
- **Overscan:** Set **OFF** to show the full image on the TV when connecting a computer. Set **ON** to show the full image on the TV when not connected with a computer.
- **Backlight:** Set the backlight brightness.

Reset Video Settings

Reset Video settings to factory default settings.

Audio Menu

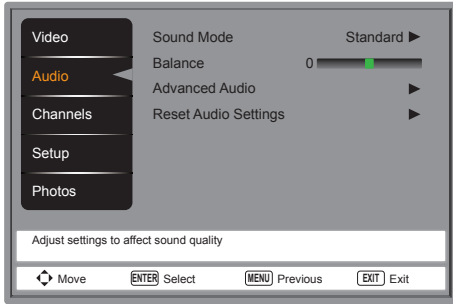

- ❑ **Sound Mode**
Select preset audio modes. The options are: **Standard**, **Movie**, **Music**, **News**, and **Custom**.
- ❑ **Balance**
Adjust the audio balance for the TV's internal left and right speakers.
- ❑ **Advanced Audio**
Select advanced audio settings.
 - **Bass**: Enhance the low frequencies.
 - **Treble**: Enhance the high frequencies.
 - **Internal Speakers**: Select **Off** if you don't need the internal speakers.
 - **Digital Output**: Select optical output options: **RAW** or **PCM** (available for digital channel and HDMI).
 - **Audio Source**: Select audio sources among **Stereo**, **Mono**, or **SAP** in analog channels.
 - **Audio Language**: Select language options in digital channels.
- ❑ **Reset Audio Settings**
Reset Audio settings to factory default settings.

Channels Menu

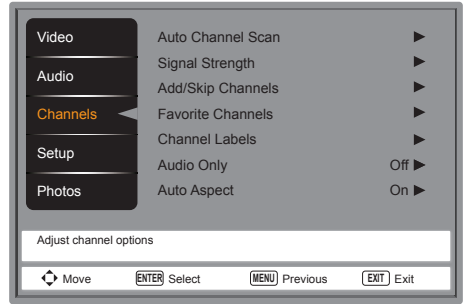

- ❑ **Auto Channel Scan**
Automatically search the available channels.
- ❑ **Signal Strength**
Access signal strength meter to help you adjust your antenna installation to optimize signal reception. (available for digital channel).
- ❑ **Add/Skip Channels**
Manually add or skip channels to the TV's program list.
- ❑ **Favorite Channels**
Add channels to create your favorite list.
- ❑ **Channel Labels**
Create labels to any channel.
- ❑ **Audio Only**
Play the audio only with picture turned off. Any press of the button except the [POWER] button on the remote control will turn on the picture.
- ❑ **Auto Aspect**
Automatically adjust the picture aspect ratio according to the TV program.

Setup Menu

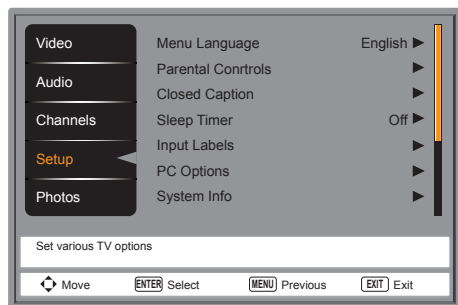

❑ Menu Language

Choose English, Spanish, or French for OSD language.

❑ Parental Controls

Set TV parental controls. This function blocks out the picture and sound of the selected rating levels.

The factory preset password to enter the **Parental Controls** feature is a 4-digit number **0000**.

- **Button Lock:** Lock or unlock all buttons on the TV's panel.
- **Block Unrated TV:** Block or unblock the unrated programs.
- **US:** Set the parental control level using the Movie Ratings or TV Ratings.
- **Canada:** Set the parental control level using the English Rating or French Rating.
- **Change Password:** Change the 4-digit password. You will have to enter the new password first and then enter again the new password to confirm. Make sure to keep your new password.
- **Region 5:** Use Region 5 to block various types of movies and television programs based on ratings systems used in the USA that you feel may be inappropriate due to its content. The Region 5 option will operate for Digital Channels (ATSC) only.
- **Reset Region 5:** Clear the downloaded RRT5 rating information and restore to the factory default settings.

❑ Closed Caption

Adjust the Closed Caption settings. The options are: **CC Mode**, **Analog Captions**, **Digital Captions**, **Digital CC Settings**.

❑ Sleep Timer

Select how long the TV will take to automatically turn itself off. The options are: **Off**, **5**, **10**, **15**, **30**, **60**, **90**, **120**, **180**, and **240** minutes.

❑ Input Labels

Create labels that match your TV's inputs to your external devices for easy identification.

❑ PC Options

Only available for PC input with PC signal. You can adjust the PC input to match your PC or Laptop output with your TV. The options are: **Auto Adjust**, **H-Position**, **V-Position**, **Clock**, **Phase**, and **Reset PC Options**.

❑ System Info

Displays the TV information.

❑ Energy Options

Select the power saving modes. The options are **Home Mode** and **Shop Mode**.

The **Home Mode** is intended for home use, and will save much energy. The **Shop Mode** sets the TV to a more energy consuming mode.

❑ Demo Mode

Turn the TV demo mode on or off.

❑ Reset AV & Setup

Reset Audio, Video, and Setup settings to factory default settings.



Photos Menu

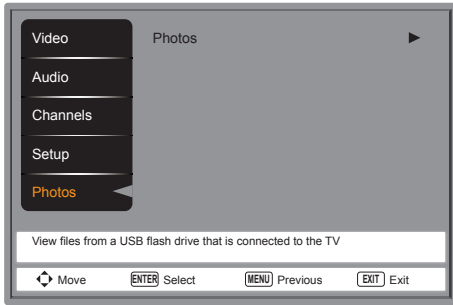

Photos

- **Browse Photos:** Find photos on the USB drive.
- **Favorite Photos:** Select only your favorite photos to show.
- **View Slideshow:** View your photos in a slideshow manner.
- **Settings:** Change the slidwshow settings. The options are: **Repeat**, **Shuffle**, **Speed**, and **Transition**.

To control while in photo folder:

- Press **UP/DOWN/LEFT/RIGHT** to browse the photo files.
- Press **ENTER** to open a folder or a photo file which will be viewed on the full screen.
- Press **MENU** to return to USB Main Menu.
- Press **FAVORITE** to add a photo file to favorite list or delete from favorite list.

To control while in full-screen photo show:

- Press **RIGHT** to go to the next image. Press **LEFT** to go to the previous image.
- Press **ENTER** to rotate the image clockwise. When press enter to rotate the photo, the rotation situation will change to Zoom Fill style.
- Press **PIX SHAPE** to zoom the image.
- Press **MENU** to return to the Folder/Photo List View.

To control while in photo slideshow:

- Press **ENTER** to play or pause slideshow.
- Press **MENU** to stop the slideshow and return to photo browser.

Data Format for USB Photo Viewer

Data format	JPEG, JPG, JPE
Max. folder layer	9
Max. number of photos	700
Max. number of favorite photos	200
Min. image resolution	75 x 75 pixels
Max. image resolution (Progressive DCT)	1024 x 768 pixels
Max. image resolution (Baseline Sequential DCT)	15360 x 8640 pixels
Supported file system	FAT32

CAUTION:

- USB photo viewer only supports USB Mass storage class devices.
- A JPEG image modified with PC may not be displayed.
- Partly degraded files might be displayed at a reduced resolution.
- Not guaranteed to support all USB devices.
- Do not use a USB Hub.
- Do not support multi-partition USB.

NOTES:

- The folder and file names may be different depending on the digital camera used.
- Support USB 2.0 Type A connector (DC5V, max. 500mA)



Problems and Solutions

If you are having problems with your LCD TV, check this trouble shooting chart to find one or more possible solutions.

Before returning your LCD TV, please visit our website at <http://www.sanyoctv.com> or call us toll free at 1-800-877-5032 We can Help!

No picture, sound (Digital Picture)

- Check the antenna / external connections.
- There may be a station trouble, no signal broadcast.
- MUTE function may be turned ON.

No Caption

- Check if station is broadcasting a Closed - Caption signal.
- Select another channel.

Cannot display picture on a full screen

- Press the [PIX SHAPE] button on the remote control to change settings.

Poor Picture/ Sound (watching Analog)

- Check if the program is in color.
- Check the antenna / external connections.
- Color or Tint may be misadjusted.
- There may be a station trouble.
- MUTE function may be turned ON.

“No Signal” message appears on screen

- Check the Audio / Video connections.
- Check the external equipment connections.
- Check the external equipment settings.
- Check the antenna connection.

Pixilation of Digital image

- Execute Signal meter in the ANT/Cable setup menu to check the signal strength.

Cannot select or scan some channels

- Channel may be removed from memory.
- Check antenna connections.
- No digital signal being broadcasted.
- Weak Signal.

No Cable channels above number 13

- Check **ANT/Cable** setup menu, **ANT** in item should set to Cable.

Remote Control will not operate TV

- Check batteries.
- Check if the TV is plugged in.

Cabinet makes popping sound

- This is a normal condition during warm - up and cool down of the plastic cabinet parts.



Specifications

Panel Type	• LCD
Panel Size	• 32" (Diagonal 31.5")
Maximum Visible Range	• 697.68(H)× 392.26(V)
Refresh Rate	• 60 Hz
Picture Resolution	• HD (1366x768)
Viewing Angle	• 178°(H), 178°(V)
Brightness	• 310 cd/m ²
Contrast Ratio	• 3000:1 (Typical)
Voltage	• AC120V~ 60 Hz
Power Consumption	• 47 Watts
Color System	• NTSC, ATSC, Clear QAM
Channel Coverage	• Low band: 55.25 to 144.00MHz • Mid band: 145.00 to 424.00MHz • High band: 425.00 to 861.00MHz
Horizontal frequency	• 30 ~ 80 KHz
Vertical frequency	• 56 ~ 75 Hz
Inputs/Outputs	• DIGITAL AUDIO OUT (S/PDIF) • COMPONENT/AV IN • ANTENNA/DTV/TV • PC IN (D-Sub) • PC/DVI (AUDIO IN) • HDMI (HDMI1/DVI, HDMI2, or HDMI3) • USB
Audio Output	• 5W + 5W
Dimensions (Including Stand)	• 732.6(L) x 204.9(W) x 493.1(H) mm
Net Weight (Including Stand)	• 7.32 kg
Operating Environment	• Operating Temperature: 0°C to 35°C • Operating Humidity: 10 % to 90 % (non-condensing) • Storage Temperature: -20°C to 60°C • Storage Humidity: 30% to 90% (non-condensing)

- Specifications are subject to change without notice.

Supported Timing Table

Resolution	PC	HDMI-DVI	Component	Horizontal Freq. (KHz)	Vertical Freq. (Hz)	Nominal Pixel Clock (MHz)
640x480@60Hz	•	•		31.469	59.940	25.175
720x400@70Hz	•	•		31.469	70.087	28.322
800x600@60Hz	•	•		37.879	60.317	40.000
1024x768@60Hz	•	•		48.363	60.004	65.000
1280x720@60Hz	•	•		44.772	59.855	74.500
1280x768@60Hz	•	•		47.396	59.995	68.250
1360x768@60Hz	•	•		47.712	60.015	85.500
720x480i 59.94/60Hz		•	•			
720x480P 59.94/60Hz		•	•			
720P 59.94/60Hz		•	•			
1080i 59.94/60Hz		•	•			
1080P 24Hz		•				
1920x1080@60Hz		•		67.500	60.000	148.500

ONE-YEAR LIMITED PARTS AND LABOR WARRANTY

THIS LIMITED PARTS AND LABOR WARRANTY IS VALID ONLY ON SANYO TELEVISIONS PURCHASED AND USED IN THE UNITED STATES OF AMERICA, CANADA, AND PUERTO RICO, EXCLUDING ALL OTHER U.S. TERRITORIES AND PROTECTORATES. THIS LIMITED WARRANTY APPLIES ONLY TO THE ORIGINAL RETAIL PURCHASER, AND DOES NOT APPLY TO PRODUCTS USED FOR INDUSTRIAL OR COMMERCIAL PURPOSES.

WARRANTY APPLICATION

FOR ONE YEAR from the date of original retail purchase Sanyo Manufacturing Corporation (SMC) warrants this TV to be free from manufacturing defects in materials and workmanship under normal use and conditions for parts and labor.

For the **FIRST 90 DAYS** from the date of original retail purchase, Sanyo Manufacturing Corporation will replace any defective TV via exchange at the retailer. **To ensure proper warranty application, keep the original-dated-sales receipt for evidence of purchase. Return the defective TV to the retailer along with the receipt and the included accessories, such as the remote control. The defective TV will be exchanged for the same model, or a replacement model of equal value, if necessary. Replacement model will be contingent on availability and at the sole discretion of Sanyo Manufacturing Corporation.**

THE FOREGOING WARRANTY IS EXCLUSIVE AND IN LIEU OF ALL OTHER WARRANTIES OF MERCHANTABILITY OR FITNESS FOR A PARTICULAR PURPOSE.

OBLIGATIONS

For one year from the date of purchase, Sanyo Manufacturing Corporation warrants this product to be free from defects in material and workmanship under normal use and conditions. During the first 90 days under this warranty for any manufacturing defect or malfunction Sanyo Manufacturing Corporation will provide a new TV via exchange at the retailer.

HOW TO MAKE A CLAIM UNDER THIS WARRANTY

Please call 1-800-877-5032. Please be prepared to give us the television's model number and serial number when you call. The model number and serial number are **printed on a label attached to** the back of the unit.

For customer assistance, call toll free 1-800-877-5032.

This warranty expresses specific contractual rights; retail purchasers may have additional statutory rights which vary from state to state.

(EFFECTIVE: March 1, 2007)

**Your Sanyo HDTV is registered at the time of purchase,
please keep sales receipt for future reference.**

For your protection in the event of theft or loss of this product, please fill in the information requested below and **KEEP IN A SAFE PLACE FOR YOUR OWN PERSONAL RECORDS.**

Model No. _____
(Located on back of unit)

Serial No. _____
(Located on back of unit)

Purchase date _____

Purchase Price _____

Where Purchased _____



Sanyo Manufacturing Corp. 3333
Sanyo Road, Forrest City, AR 72335

Printed in China, 2013